

RECOMMENDED P.C. BOARD LAYOUT

NOTES:

- 1.HUOSING: LCP HIGH-TEMP THERMOPLASTIC UL94V-0 COLOR:BEIGE
- 2.TERMINAL:PHOSPHOR BRONZE
PLATING:1μ" GOLD FLASH OVERALL 50~100μ" NICKEL UNDER PLATED.
- 3.CODING INFORMATION: LB638-GxxP-COR

PACKING: R: CARRIER REEL
STANDARD TYPE
COLOR:BEIGE
PLUG
PIN
PLATING: G:GOLD FLASH
0.8 BTB
HEIGHT: 38--3.8H
LXWCONN BTB CONNECTOR SERIES

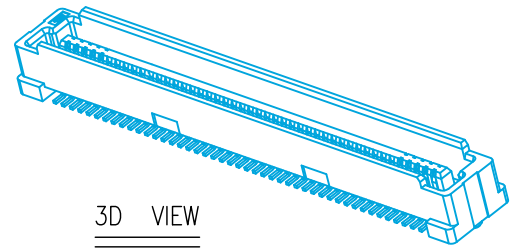

3D VIEW

NO.of contacts	Dimensions			
	A.	B.	C.	D.
40	21.80	15.20	16.80	20.20
60	29.80	23.20	24.80	28.20
80	37.80	31.20	32.80	36.20
100	45.80	39.20	40.80	44.20
120	53.80	47.20	48.80	52.20
140	61.80	55.20	56.80	60.20
160	69.80	63.20	64.80	68.20
180	77.80	71.20	72.80	76.20
200	85.80	79.20	80.80	84.20



CUSTOMER		连兴旺电子(深圳)有限公司 LXWCONN ELECTRONICS (SHENZHEN) CO., LTD	
一般公差 GENERAL TOLERANCE .X ±0.25 .XX ±0.20 .XXX ±0.10 ANGLES ±1°	制图 (DR): Kavin 2017.07.19	品名(TITLE): 0.8mm PITCH BTB CONNECTOR PLUG ASSEMBLY 5.0H TYPE	
修订 SER	修改摘要 REVISION DESCRIPTION	签名 SIGNATURE	日期 DATE
版本 (REV) A		审核 (CHKD):	料号 (PART NO): LB638-GxxP-COR 比例 (SCALE): 1:8 单位 (UNITS): mm 张数 (SHEET): 1 OF 1 图幅 (SIZE): A4
核准 (APPD):		核准 (APPD):	

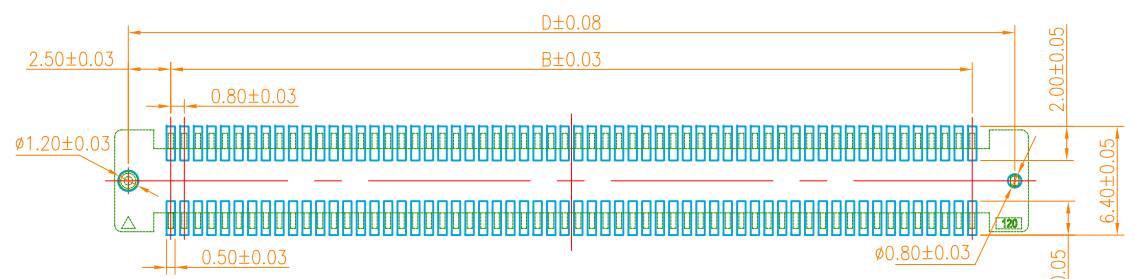
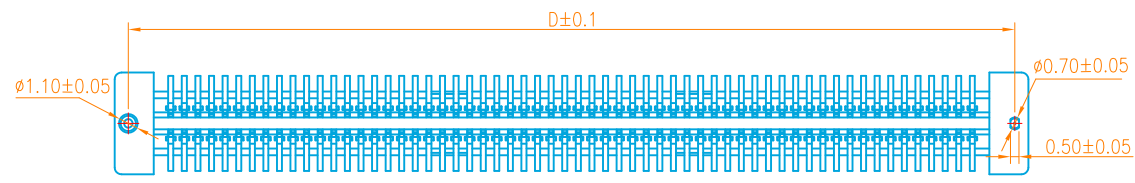
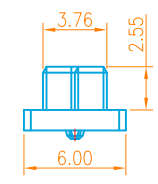
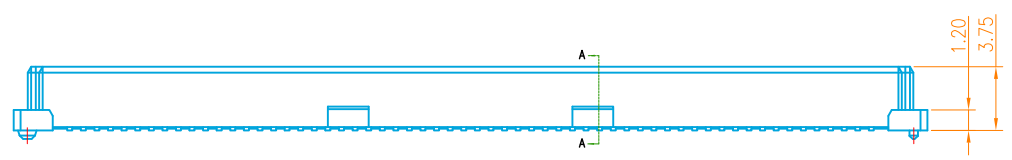
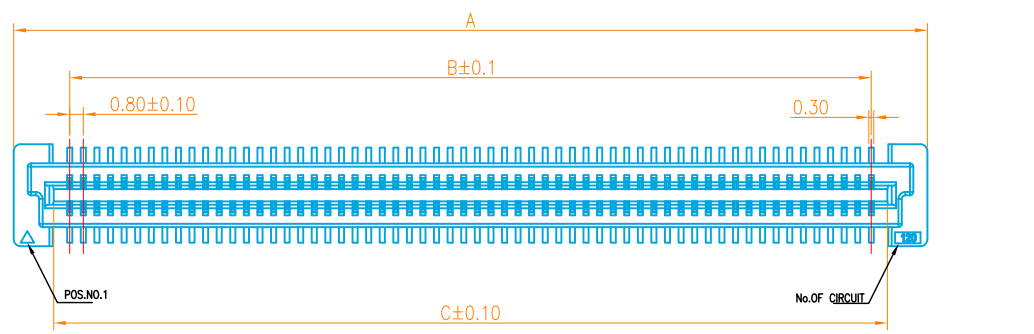

RECOMMENDED P.C.BOARD LAYOUT

NOTES:

- HUOSING: LCP HIGH-TEMP THERMOPLASTIC UL94V-0 COLOR:BEIGE
- TERMINAL:PHOSPHOR BRONZE
PLATING:1μ" GOLD FLASH OVERALL 50~100μ" NICKEL UNDER PLATED.
- CODING INFORMATION: LB612-GxxS-COR

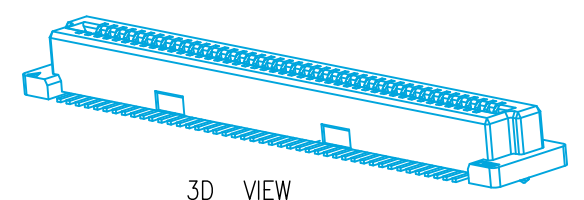
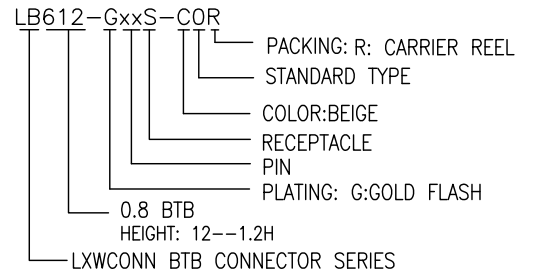

3D VIEW

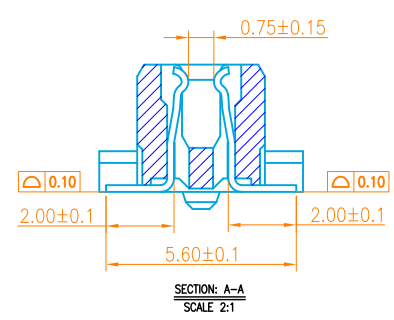

NO.of contacts	Dimensions			
	A.	B.	C.	D.
40	21.80	15.20	17.10	20.20
60	29.80	23.20	25.10	28.20
80	37.80	31.20	33.10	36.20
100	45.80	39.20	41.10	44.20
120	53.80	47.20	49.10	52.20
140	61.80	55.20	57.10	60.20
160	69.80	63.20	65.10	68.20
180	77.80	71.20	73.10	76.20
200	85.80	79.20	81.10	84.20

CUSTOMER		连兴旺电子(深圳)有限公司			
		LXWCONN ELECTRONICS (SHENZHEN) CO., LTD			
一般公差 GENERAL TOLERANCE	制图 (DR): Kavin 2017.07.19	0.8mm PITCH BTB CONNECTOR			
.X ±0.25	审核 (CHKD):	品名(TITLE): RECEPTACLE ASSEMBLY 5.0H TYPE			
.XX ±0.20	料号 (PART NO):	LB612-GxxS-COR			
.XXX ±0.10	比例 (SCALE)	单位 (UNITS)	张数 (SHEET)	图幅 (SIZE)	
ANGLES ±1°	1:8	mm	1 OF 1	A4	
修订 (REV)	修改摘要 REVISION DESCRIPTION	签名 SIGNATURE	日期 DATE	版本 (REV)	
A					

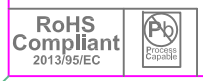

修订 (REV)	修改摘要 REVISION DESCRIPTION	签名 SIGNATURE	日期 DATE	版本 (REV)
A				